

Catalog | February 2015

Low voltage  
General performance  
IE2 cast iron motors

With expertise, and a comprehensive portfolio of products and life-cycle services, we help value-minded industrial customers improve their energy efficiency and productivity.

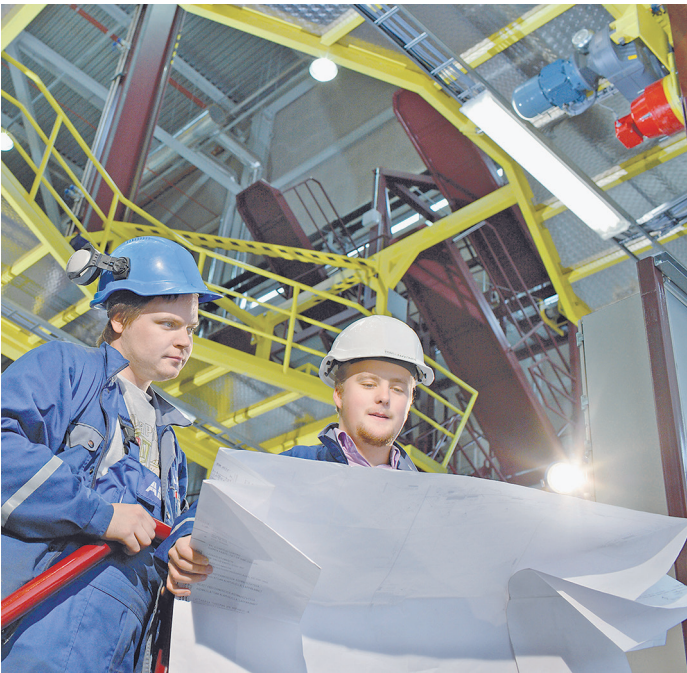

# Low voltage General performance IE2 cast iron motors

## Sizes 71 to 355, 0.18 to 355 kW



<b>General information</b>	<b>4</b>
Mounting arrangements .....	4
Cooling .....	5
Degrees of protection: IP code/IK code .....	6
Insulation .....	7
Voltage and frequency .....	8
<b>Cast iron IE2 motors</b>	<b>10</b>
Ordering information .....	10
Rating plates .....	11
Technical data .....	12
Variant codes .....	15
Mechanical design .....	17
Dimension drawings .....	22
Motors in brief .....	25
<b>Total product offering</b>	<b>28</b>
<b>Life cycle services and support</b>	<b>29</b>

# General information

## Mounting arrangements

### Foot-mounted motor

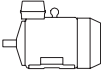
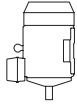
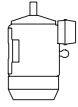
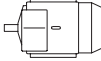
Code I / code II

					
IM B3	IM V5	IM V6	IM B6	IM B7	IM B8
IM 1001	IM 1011	IM 1031	IM 1051	IM 1061	IM 1071

Product code pos. 12

A: foot-mounted, term.box top

### Flange-mounted motor, large flange

Code I / code II

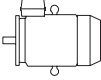
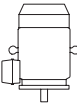
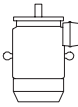
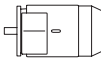
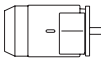
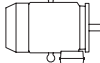
					
IM B5	IM V1	IM V3	*)	*)	*)
IM 3001	IM 3011	IM 3031	IM 3051	IM 3061	IM 3071

Product code pos. 12

B: flange mounted, large flange

### Flange-mounted motor, small flange

Code I / code II

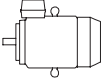
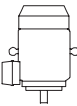
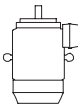
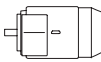
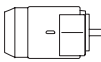
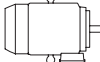



					
IM B14	IM V18	IM V19	*)	*)	*)
IM 3601	IM 3611	IM 3631	IM 3651	IM 3661	IM 3671

Product code pos. 12

047=B14 from B5

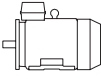
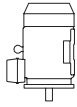
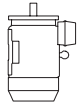
### Foot- and flange-mounted motor with feet, large flange

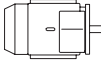
Code I / code II



					
IM B35	IM V15	IM V36	*)	*)	*)
IM 2001	IM 2011	IM 2031	IM 2051	IM 2061	IM 2071

Product code pos. 12

009=B35 from B3

### Foot- and flange-mounted motor with feet, small flange

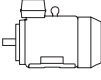
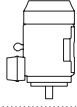
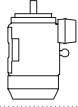
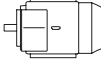
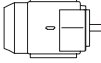
Code I / code II

					
IM B34	IM V17	IM 2131	IM 2151	IM 2161	IM 2171
IM 2101	IM 2111	IM 2131	IM 2151	IM 2161	IM 2171

Product code pos. 12

008=B34 from B3

### Foot-mounted motor, shaft with free extensions

Code I / code II

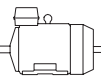
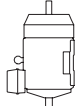
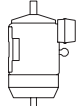
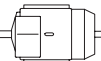
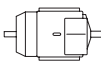
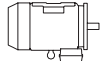
					
IM 1002	IM 1012	IM 1032	IM 1052	IM 1062	IM 1072

Product code pos. 12

\*) Not stated in IEC 60034-7.

Note: If the motor is mounted shaft upwards, take measures to prevent water or any other liquid from running down the shaft into the motor.

# General information

## Cooling

Designation system concerning methods of cooling refers to standard IEC 60034-6.

### Explanation of the product code

International Cooling	Circuit arrangement	Primary coolant	Method of movement of primary coolant	Secondary coolant	Method of movement of secondary coolant
IC	4	(A)	1	(A)	6
	1	2	3	4	5

#### Position 1

0:	Free circulation (open circuit)
4:	Free circulation (open circuit)

#### Position 2

A:	For air (omitted for simplified designation)
----	--

#### Position 3

0:	Free convection
1:	Self-circulation
6:	Machine-mounted independent component

#### Position 4

A:	For air (omitted for simplified designation)
W:	For water

#### Position 5

0:	Free convection
1:	Self-circulation
6:	Machine-mounted independent component
8:	Relative displacement

# General information

## Degrees of protection: IP code/IK code

Classification of degrees of protection provided by enclosures of rotating machines refers to:

- Standard IEC 60034-5 or EN 60529 for IP code
- Standard EN 50102 for IK code

### IP protection

Protection of persons against getting in contact with (or approaching) live parts and against contact with moving parts inside the enclosure. Also protection of the machine against ingress of solid foreign objects. Protection of machines against the harmful effects due to the ingress of water.

### Explanation of the IP code

Ingress protection	Degree of protection to persons and to parts of the motors inside the enclosure	Degree of protection provided by the enclosure with respect to harmful effects due to ingress of water
IP	5	5
	1	2

#### Position 1

2:	Motors protected against solid objects greater than 12 mm
4:	Motors protected against solid objects greater than 1 mm
5:	Dust-protected motors
6:	Dust-tight motors

#### Position 2

3:	Motors protected against spraying water
4:	Motors protected against splashing water
5:	Motors protected against water jets
6:	Motors protected against heavy seas

### IK code

Classification of degrees of protection provided by enclosure for motors against external mechanical impacts.

### Explanation of the IK code

International mechanical protection	Characteristic group
IK	08
	1

#### Position 1

#### Relation between IK code and impact energy:

IK code	Impact energy/Joule
0:	Not protected according to EN 50102
01:	0.15
02:	0.2
03:	0.35
04:	0.5
05:	0.7
06:	1
07:	2
08:	5 (ABB Standard)
09:	10
10:	20

# General information

## Insulation

ABB uses class F insulation, which, with temperature rise B, is the most common requirement among industry today.

The use of class F insulation with class B temperature rise gives ABB products a 25 °C safety margin. This can be used to increase the loading for limited periods, to operate at higher ambient temperatures or altitudes, or with greater voltage and frequency tolerances. It can also be used to extend insulation. For instance, a 10 K temperature reduction will extend the insulation life.

### Thermal class 130 (B)

- Nominal ambient temperature 40 °C
- Max permissible temperature rise 80 K
- Hot spot temperature margin 10 K

### Thermal class 155 (F)

- Nominal ambient temperature 40 °C
- Max permissible temperature rise 105 K
- Hot spot temperature margin 10 K

### Thermal class 180 (H)

- Nominal ambient temperature 40 °C
- Max permissible temperature rise 125 K
- Hot spot temperature margin 10 K

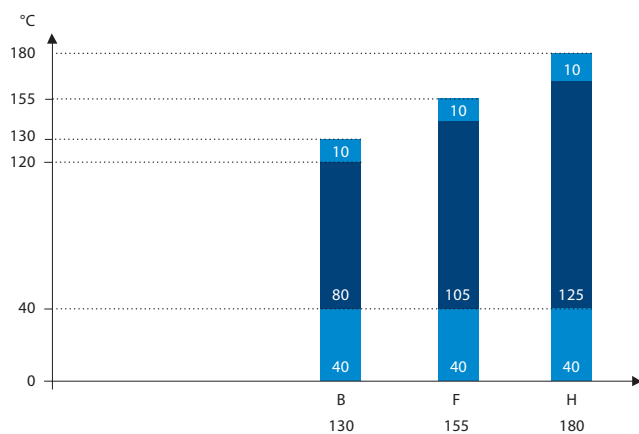

Safety margins per thermal class

# General information

## Voltage and frequency

The impact on temperature rise caused by voltage and frequency fluctuation is defined in IEC 60034-1. The standard divides the combinations into two zones, A and B. Zone A is the combination of voltage deviation of +/-5 % and frequency deviation of +/-2 %. Zone B is the combination of voltage deviation of +/-10 % and frequency deviation of +/-3%. This is illustrated in figure below.

Motors are capable of supplying the rated torque in both zones A and B, but the temperature rise will be higher than at rated voltage and frequency. Motors can be run in zone B only for a short period of time.

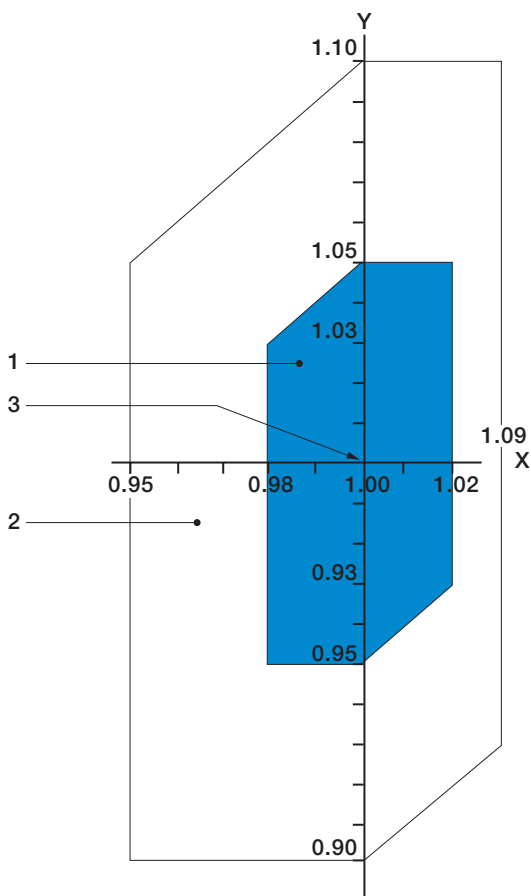

Figure Voltage and frequency deviation in zones A and B.

Key	
X axis	frequency p.u.
Y axis	voltage p.u.
1	zone A
2	zone B (outside zone A)
3	rating point



# General performance IE2 cast iron motors

## Sizes 71 to 355, 0.18 to 355 kW

<b>Ordering information</b>	<b>10</b>
<b>Rating plates</b>	<b>11</b>
<b>Technical data IE2</b>	<b>12</b>
3000 r/min motors.....	12
1500 r/min motors.....	13
1000 r/min motors.....	14
<b>Variant codes</b>	<b>15</b>
<b>Mechanical design</b>	<b>17</b>
Bearings.....	17
Terminal box.....	21
<b>Dimension drawings</b>	<b>22</b>
<b>Motors in brief</b>	<b>25</b>

# Ordering information

## Explanation of the product code

Motor type	Motor size	Product code	Mounting arrangement code, Voltage and frequency code, Generation code	Variant codes
M2BAX	112MA	3GBA 112 310	- ADC	002, etc.
		1 2 3 4 5 6 7 8 9 10 11 12 13 14		

When placing an order, specify motor type, size and product code according to the following example.

Example	
Motor type	M2BAX 112 MA
Pole number	4
Mounting arrangement (IM-code)	IM B3 (IM 1001)
Rated output	4 kW
Product code	3GBA 112 310-ADC
Variant codes if needed	

### Positions 1 to 4

3GBA: Totally enclosed fan cooled squirrel cage motor with cast iron frame

### Positions 5 and 6

IEC size	
07:	71
08:	80
09:	90
10:	100
11:	112
13:	132
16:	160
18:	180
20:	200
22:	225
25:	250
28:	280
31:	315
35:	355

### Position 7

Speed (Pole pairs)	
1:	2 poles
2:	4 poles
3:	6 poles

### Positions 8 to 10

Running number

### Position 11

-(dash)

### Position 12 (marked with black dot in data tables)

Mounting arrangement	
A:	Foot-mounted, top-mounted terminal box
B:	Flange-mounted, large flange

### Position 13 (marked with black dot in data tables)

Voltage and frequency	
Single-speed motors	
D:	400 VΔ, 690 VY, 380 VΔ, 660 VY, 50 Hz 440 VΔ, 460 VΔ, 60 Hz
S:	230 VΔ, 400 VY, 220 VΔ, 380 VY, 50 Hz 440 VY, 460 VΔ 60 Hz*

### Position 14

A, B, C...= Generation code followed by variant codes

Efficiency values are given according to IEC 60034-2-1; 2014

For detailed dimension drawings please see our web-pages 'www.abb.com/motors&generators' or contact ABB.

# Rating plates

The motor's main rating plate shows the motor's performance values with various connections at nominal speed. The rating plate also shows the efficiency level (IE2, IE3), year of manufacture, and the lowest nominal efficiency at 100, 75, and 50 % nominal load.

<b>ABB</b>						
<b>CE</b> IE2 IEC 60034-1						
3 ~ Motor		M2BAX 90LA 4		IMB3/IM1001		2015
No. _____ Ins.cl. _____ F IP 55						
V	Hz	kW	r/min	A	cos φ	Duty
230 Δ	50	1.5	1441	6.11	0.74	S1
400 Y	50	1.5	1441	3.53	0.74	S1
220 Δ	50	1.5	1435	6.10	0.78	S1
380 Y	50	1.5	1435	3.53	0.78	S1
460 Y	60	1.5	1741	3.22	0.70	S1
440 Y	60	1.5	1735	3.17	0.74	S1
50Hz: IE2 - 82.8(100%) - 81.9(75%) - 80.0(50%)						
60Hz: IE2 - 84.0(100%) - 83.3(75%) - 80.2(50%)						
Prod. code		3GBA092510-ASC				
6205-2Z/C3		6204-2Z/C3		23 kg		

Rating plate for IE2 General performance cast iron M2BAX motor, size 90

<b>ABB</b>						
<b>CE</b> IE2 IEC 60034-1						
3 ~ Motor		M2BAX 160MLA 4		IMB3/IM1001		2015
No. _____ Ins.cl. _____ F IP 55						
V	Hz	kW	r/min	A	cos φ	Duty
690 Y	50	11	1466	13.0	0.79	S1
400 Δ	50	11	1466	22.4	0.79	S1
660 Y	50	11	1461	13.2	0.82	S1
380 Δ	50	11	1461	22.7	0.82	S1
460 Δ	60	11	1773	18.7	0.81	S1
440 Δ	60	11	1770	19.1	0.83	S1
50Hz: IE2 - 89.8(100%) - 89.9(75%) - 89.2(50%)						
60Hz: IE2 - 91.0(100%) - 90.7(75%) - 89.4(50%)						
Prod. code		3GBA162410-ADC				
6209-2Z/C3		6209-2Z/C3		110 kg		

Rating plate for IE2 General performance cast iron M2BAX motor, size 160

# Technical data

## IE2 cast iron motors, 3000 r/min

IP 55 - IC 411 - Insulation class F, temperature rise class B  
IE2 efficiency class according to IEC 60034-30-1; 2014

Output kW	Motor type	Product code	Speed r/min	Efficiency IEC 60034-30-1; 2014			Power factor Cosφ	Current Torque					Moment of inertia J = 1/4 GD <sup>2</sup> kgm <sup>2</sup>	Weight kg	Sound pressure Level L <sub>PA</sub> dB
				Full load 100%	3/4 load 75%	1/2 load 50%		I <sub>N</sub> A	I <sub>s</sub> /I <sub>N</sub>	T <sub>N</sub> Nm	T <sub>f</sub> /T <sub>N</sub>	T <sub>b</sub> /T <sub>N</sub>			
3000 r/min = 2 poles				400 V 50 Hz				CENELEC-design							
0.37	M2BAX 71 MA 2	3GBA071310-••C	2807	73.5	71.4	67.3	0.80	0.91	5.1	1.26	2.8	3.4	0.000330	9	56
0.55	M2BAX 71 MB 2	3GBA071320-••C	2820	75.5	73.9	70.2	0.79	1.33	5.5	1.86	3.6	3.2	0.000410	10	58
0.75	M2BAX 80 MA 2	3GBA081310-••C	2830	77.4	76.7	74.4	0.83	1.69	5.7	2.5	3.1	4.3	0.000670	13	63
1.1	M2BAX 80 MB 2	3GBA081320-••C	2849	79.6	79.7	77.7	0.84	2.4	5.8	3.7	3.2	4.1	0.000880	14	62
1.5	M2BAX 90 SA 2	3GBA091110-••C	2890	81.3	80.0	76.9	0.80	3.3	7.1	4.9	3.1	3.9	0.00208	20	66
2.2	M2BAX 90 LA 2	3GBA091510-••C	2897	83.2	82.9	81.2	0.85	4.5	7.7	7.3	3.1	3.8	0.00274	23	67
3	M2BAX 100 LA 2	3GBA101510-••C	2919	84.6	83.7	81.2	0.85	6.0	8.7	9.8	4.2	5.0	0.00475	32	74
4	M2BAX 112 MA 2	3GBA111310-••C	2916	85.8	85.3	83.1	0.87	7.7	9.1	13.1	4.1	4.7	0.00561	36	74
5.5	M2BAX 132 SA 2	3GBA131110-••C	2921	87.0	85.9	83.6	0.86	10.6	8.3	18.0	2.6	4.3	0.0117	54	74
7.5	M2BAX 132 SB 2	3GBA131120-••C	2916	88.1	87.5	85.8	0.85	14.5	8.7	24.6	3.1	4.5	0.0132	58	74
11	M2BAX 160 MLA 2	3GBA161410-••C	2931	89.4	89.4	88.4	0.86	20.7	6.6	35.9	2.5	3.5	0.0413	102	72
15	M2BAX 160 MLB 2	3GBA161420-••C	2938	90.3	90.6	89.8	0.89	26.9	7.6	48.9	3.0	3.5	0.0538	115	72
18.5	M2BAX 160 MLC 2	3GBA161430-••C	2939	90.9	91.0	90.3	0.88	33.4	7.9	60.1	3.1	3.8	0.0600	123	73
22	M2BAX 180 MLA 2	3GBA181410-••C	2943	91.3	91.4	90.7	0.88	39.5	8.4	71.4	3.8	3.9	0.0735	150	72
30	M2BAX 200 MLA 2	3GBA201410-••C	2957	92.0	91.5	90.1	0.85	55.4	8.6	97.1	4.0	4.2	0.110	198	81
37	M2BAX 200 MLB 2	3GBA201420-••C	2951	92.5	92.5	92.1	0.90	64.2	8.4	120	3.6	3.7	0.141	229	80
45	M2BAX 225 SMA 2	3GBA221210-••C	2962	92.9	92.8	92.1	0.87	80.4	8.8	145	3.8	3.8	0.226	273	82
55	M2BAX 250 SMA 2	3GBA251210-••C	2965	93.2	93.2	92.6	0.88	96.8	7.4	177	3.4	3.0	0.344	334	78
75	M2BAX 280 SA 2	3GBA281110-••C	2977	94.0	93.7	92.3	0.88	130	7.6	240	2.1	3.0	0.800	546	78
90	M2BAX 280 SMB 2	3GBA281220-••C	2976	94.3	94.2	93.1	0.90	153	7.4	288	2.1	2.9	0.900	570	78
110	M2BAX 315 SMA 2	3GBA311210-••C	2982	94.6	94.1	92.7	0.86	195	7.6	352	2.0	3.0	1.20	750	78
132	M2BAX 315 SMB 2	3GBA311220-••C	2982	94.9	94.6	93.4	0.88	228	7.4	422	2.2	3.0	1.40	810	78
160	M2BAX 315 SMC 2	3GBA311230-••C	2981	95.2	95.0	94.1	0.89	272	7.5	512	2.3	3.0	1.70	900	78
200	M2BAX 315 MLA 2	3GBA311410-••C	2980	95.3	95.2	94.4	0.90	336	7.7	640	2.6	3.0	2.10	1020	83
250	M2BAX 355 SMA 2	3GBA351210-••C	2983	95.4	95.2	94.3	0.89	424	6.8	800	1.5	2.8	2.70	1310	83
315	M2BAX 355 SMB 2	3GBA351220-••C	2980	95.4	95.4	94.7	0.89	535	7.2	1009	1.9	2.8	3.40	1450	83
355	<sup>1)</sup> M2BAX 355 SMC 2	3GBA351230-••C	2983	95.5	95.5	94.9	0.88	609	7.4	1136	2.1	2.7	3.60	1520	83

<sup>1)</sup> Temperature rise class F

# Technical data

## IE2 cast iron motors, 1500 r/min

IP 55 - IC 411 - Insulation class F, temperature rise class B  
IE2 efficiency class according to IEC 60034-30-1; 2014

Output kW	Motor type	Product code	Speed r/min	Efficiency IEC 60034-30-1; 2014			Power factor Cos $\phi$	Current Torque					Moment of inertia J = 1/4 GD <sup>2</sup> kgm <sup>2</sup>	Weight kg	Sound pressure Level L <sub>PA</sub> dB
				Full load 100%	3/4 load 75%	1/2 load 50%		I <sub>N</sub> A	I <sub>s</sub> /I <sub>N</sub>	T <sub>N</sub> Nm	T <sub>f</sub> /T <sub>N</sub>	T <sub>b</sub> /T <sub>N</sub>			
1500 r/min = 4 poles				400 V 50 Hz				CENELEC-design							
0.25	M2BAX 71 MA 4	3GBA072310-••C	1415	67.0	63.1	56.6	0.73	0.74	4.4	1.68	2.1	2.8	0.000587	9	49
0.37	M2BAX 71 MB 4	3GBA072320-••C	1407	69.5	67.2	62.2	0.77	1.00	4.4	2.5	1.9	2.7	0.000760	10	46
0.55	M2BAX 80 MA 4	3GBA082310-••C	1413	73.5	72.0	67.8	0.76	1.42	5.1	3.7	2.0	2.9	0.00156	13	54
0.75	M2BAX 80 MB 4	3GBA082320-••C	1462	79.6	77.1	73.2	0.71	1.92	6.7	5.0	3.1	3.9	0.00247	17	53
1.1	M2BAX 90 SA 4	3GBA092110-••C	1447	81.4	79.5	75.7	0.73	2.7	6.6	7.4	3.2	4.3	0.00372	21	51
1.5	M2BAX 90 LA 4	3GBA092510-••C	1441	82.8	81.6	78.4	0.74	3.5	6.9	10.0	3.1	4.2	0.00462	23	55
2.2	M2BAX 100 LA 4	3GBA102510-••C	1445	84.3	83.4	81.2	0.78	4.8	7.1	14.5	2.6	3.8	0.00759	31	55
3	M2BAX 100 LB 4	3GBA102520-••C	1443	85.5	85.0	82.9	0.79	6.4	7.7	19.8	2.8	4.2	0.00939	35	58
4	M2BAX 112 MA 4	3GBA112310-••C	1442	86.6	86.2	84.6	0.79	8.4	7.5	26.5	4.0	4.3	0.0120	41	56
5.5	M2BAX 132 SA 4	3GBA132110-••C	1457	87.7	87.5	86.2	0.78	11.6	6.9	36.0	2.5	3.4	0.0257	57	66
7.5	M2BAX 132 MA 4	3GBA132310-••C	1457	88.7	88.6	87.5	0.78	15.6	7.2	49.1	2.6	3.6	0.0320	68	66
11	M2BAX 160 MLA 4	3GBA162410-••C	1466	89.8	89.9	89.2	0.79	22.4	7.0	71.5	3.2	3.2	0.0784	110	67
15	M2BAX 160 MLB 4	3GBA162420-••C	1468	90.6	91.1	90.5	0.82	29.1	8.0	97.7	3.2	3.7	0.100	125	66
18.5	M2BAX 180 MLA 4	3GBA182410-••C	1470	91.2	91.5	90.6	0.80	36.6	8.5	120	3.7	4.2	0.120	155	65
22	M2BAX 180 MLB 4	3GBA182420-••C	1472	91.6	91.3	90.2	0.78	44.4	9.2	143	4.1	4.6	0.139	168	66
30	M2BAX 200 MLA 4	3GBA202410-••C	1476	92.3	92.4	92.0	0.81	57.9	6.8	194	3.0	3.2	0.236	222	68
37	M2BAX 225 SMA 4	3GBA222210-••C	1479	92.7	92.7	92.2	0.82	70.3	7.4	239	3.1	3.3	0.350	263	69
45	M2BAX 225 SMB 4	3GBA222220-••C	1481	93.1	93.0	92.3	0.81	86.1	7.9	290	3.5	3.5	0.416	290	69
55	M2BAX 250 SMA 4	3GBA252210-••C	1480	93.5	93.4	92.7	0.83	102	7.6	355	3.3	3.3	0.533	339	77
75	M2BAX 280 SA 4	3GBA282110-••C	1484	94.2	94.2	93.5	0.85	135	6.9	482	2.5	2.8	1.25	515	71
90	M2BAX 280 SMB 4	3GBA282220-••C	1483	94.4	94.6	94.1	0.86	160	7.2	579	2.5	2.7	1.50	575	71
110	M2BAX 315 SMA 4	3GBA312210-••C	1487	94.7	94.6	93.8	0.86	194	7.2	706	2.0	2.5	2.30	775	78
132	M2BAX 315 SMB 4	3GBA312220-••C	1487	95.0	95.0	94.3	0.86	233	7.1	847	2.3	2.7	2.60	830	78
160	M2BAX 315 SMC 4	3GBA312230-••C	1487	95.2	95.3	94.6	0.85	285	7.2	1027	2.4	2.9	2.90	870	78
200	M2BAX 315 MLA 4	3GBA312410-••C	1486	95.3	95.4	94.9	0.86	352	7.0	1285	2.3	2.8	3.50	995	78
250	M2BAX 355 SMA 4	3GBA352210-••C	1488	95.2	95.2	94.4	0.85	445	6.7	1604	2.0	2.6	5.40	1400	82
315	<sup>1)</sup> M2BAX 355 SMB 4	3GBA352220-••C	1488	95.5	95.5	94.8	0.85	560	7.3	2021	2.2	2.7	6.90	1570	82
355	<sup>1)</sup> M2BAX 355 SMC 4	3GBA352230-••C	1487	95.5	95.7	95.2	0.86	623	6.8	2279	2.4	2.7	7.20	1650	82

<sup>1)</sup> Temperature rise class F

# Technical data

## IE2 cast iron motors, 1000 r/min

IP 55 - IC 411 - Insulation class F, temperature rise class B  
IE2 efficiency class according to IEC 60034-30-1; 2014

Output kW	Motor type	Product code	Speed r/min	Efficiency IEC 60034-30-1; 2014			Power factor Cosφ	Current Torque					Moment of inertia J = 1/4 GD <sup>2</sup> kgm <sup>2</sup>	Weight kg	Sound pressure Level L <sub>PA</sub> dB
				Full load 100%	3/4 load 75%	1/2 load 50%		I <sub>N</sub> A	I <sub>s</sub> /I <sub>N</sub>	T <sub>N</sub> Nm	T <sub>f</sub> /T <sub>N</sub>	T <sub>b</sub> /T <sub>N</sub>			
1000 r/min = 6 poles				400 V 50 Hz				GENELEC-design							
0.18	M2BAX 71 MA 6	3GBA073310-••C	910	59.0	54.7	47.5	0.72	0.61	3.3	1.87	2.0	2.4	0.000823	9	40
0.25	M2BAX 71 MB 6	3GBA073320-••C	913	63.0	59.9	53.8	0.71	0.81	3.6	2.6	2.4	2.8		10	47
0.37	M2BAX 80 MA 6	3GBA083310-••C	919	68.0	65.9	60.7	0.74	1.06	4.2	3.8	2.5	2.7	0.00173	13	49
0.55	M2BAX 80 MB 6	3GBA083320-••C	921	71.0	69.6	64.9	0.73	1.53	4.4	5.7	2.9	3.0	0.00234	14	47
0.75	M2BAX 90 SA 6	3GBA093110-••C	949	75.9	73.0	67.7	0.62	2.3	5.1	7.6	3.3	3.7	0.00438	21	50
1.1	M2BAX 90 LA 6	3GBA093510-••C	936	78.1	76.2	72.8	0.67	3.0	4.6	11.1	3.0	3.3	0.00507	24	48
1.5	M2BAX 100 LA 6	3GBA103510-••C	953	79.8	78.4	75.1	0.67	4.1	5.2	15.0	2.6	3.1	0.00795	31	56
2.2	M2BAX 112 MA 6	3GBA113310-••C	956	81.8	80.4	77.4	0.68	5.7	5.5	21.9	2.9	3.5	0.0116	40	54
3	M2BAX 132 SA 6	3GBA133110-••C	967	83.3	82.5	80.2	0.65	8.0	5.5	29.5	2.0	3.0	0.0251	55	60
4	M2BAX 132 MA 6	3GBA133310-••C	965	84.6	84.2	82.4	0.70	9.8	5.7	40.0	2.6	3.3	0.0294	63	62
5.5	M2BAX 132 MB 6	3GBA133320-••C	964	86.0	85.9	84.7	0.68	13.6	5.8	54.2	2.2	2.9	0.0397	77	62
7.5	M2BAX 160 MLA 6	3GBA163410-••C	974	87.2	87.5	87.0	0.76	16.3	6.6	73.7	1.9	3.2	0.0811	113	65
11	M2BAX 160 MLB 6	3GBA163420-••C	971	88.7	89.4	89.8	0.79	22.7	6.6	108	1.6	2.8	0.102	133	57
15	M2BAX 180 MLA 6	3GBA183410-••C	971	89.7	90.0	89.6	0.77	31.3	7.4	147	2.4	3.9	0.136	168	62
18.5	M2BAX 200 MLA 6	3GBA203410-••C	978	90.4	90.7	90.0	0.77	38.4	6.1	181	2.0	2.9	0.204	205	61
22	M2BAX 200 MLB 6	3GBA203420-••C	978	90.9	91.1	90.5	0.78	44.8	6.2	215	1.8	2.9	0.227	219	62
30	M2BAX 225 SMA 6	3GBA223210-••C	987	91.7	91.5	90.5	0.79	59.8	7.0	290	2.7	3.2	0.579	282	64
37	M2BAX 250 SMA 6	3GBA253210-••C	986	92.2	92.5	91.9	0.81	71.5	6.9	359	2.6	2.9	0.783	336	66
45	M2BAX 280 SA 6	3GBA283110-••C	990	92.8	93.0	92.1	0.84	83.3	7.0	434	2.5	2.5	1.85	500	71
55	M2BAX 280 SB 6	3GBA283120-••C	990	93.3	93.5	92.9	0.84	101	7.0	530	2.7	2.6	2.20	540	71
75	M2BAX 315 SMA 6	3GBA313210-••C	992	94.0	94.0	93.0	0.81	142	7.0	721	2.1	2.7	3.20	705	75
90	M2BAX 315 SMB 6	3GBA313220-••C	992	94.3	94.4	93.6	0.83	165	7.2	866	2.1	2.7	4.10	800	75
110	M2BAX 315 SMC 6	3GBA313230-••C	992	94.7	94.8	94.2	0.83	201	7.0	1058	2.2	2.7	4.90	870	75
132	M2BAX 315 MLA 6	3GBA313410-••C	992	94.9	95.0	94.4	0.83	241	7.2	1270	2.4	2.7	5.80	980	75
160	M2BAX 355 SMA 6	3GBA353210-••C	992	94.9	95.0	94.4	0.83	293	6.2	1540	2.1	2.3	7.30	1290	77
200	M2BAX 355 SMB 6	3GBA353220-••C	992	95.2	95.4	94.9	0.84	360	6.5	1925	2.1	2.3	9.70	1440	77
250	<sup>1)</sup> M2BAX 355 SMC 6	3GBA353230-••C	991	95.3	95.5	95.2	0.84	450	6.7	2409	2.3	2.3	11.3	1590	77

<sup>1)</sup> Temperature rise class F

# Variant codes

## IE2 Cast iron motors

Variant codes specify additional options and features to the standard motor. The desired features are listed as three-digit variant codes in the motor order. Note also that there are variants that cannot be used together.

Code/Variants, M2BAX	Frame size													
	71	80	90	100	112	132	160	180	200	225	250	280	315	355
<b>Bearings and Lubrication</b>														
037	Roller bearing at D-end.	-	-	-	-	-	•	•	•	•	•	•	•	•
040	Heat-resistant grease	•	•	•	•	•	•	•	•	•	•	•	-	-
041	Bearings regreasable via grease nipples.	-	-	-	-	-	•	•	•	•	•	○	○	○
043	SPM compatible nipples for vibration measurement	•	•	•	•	•	•	•	•	•	•	•	•	•
188	63-series bearing in D-end	-	•	•	•	•	•	•	•	•	•	-	-	-
<b>Branch standard designs</b>														
178	Stainless steel / acid proof bolts.	•	•	•	•	•	•	•	•	•	•	•	•	•
209	Non-standard voltage or frequency, (special winding).	•	•	•	•	•	•	•	•	•	•	-	-	-
<b>Cooling system</b>														
068	Light alloy metal fan	•	•	•	•	•	•	•	•	•	•	•	•	•
075	Cooling method IC418 (without fan).	•	•	•	•	•	•	•	•	•	•	-	-	-
183	Separate motor cooling (fan axial, N-end).	•	•	•	•	•	•	•	•	•	•	-	-	-
<b>Documentation</b>														
141	Binding dimension drawing.	•	•	•	•	•	•	•	•	•	•	•	•	•
<b>Earthing Bolt</b>														
067	External earthing bolt.	○	○	○	○	○	○	○	○	○	○	○	○	○
<b>Heating elements</b>														
450	Heating element, 100-120 V	•	•	•	•	•	•	•	•	•	•	•	•	•
451	Heating element, 200 - 240 V	•	•	•	•	•	•	•	•	•	•	•	•	•
<b>Insulation system</b>														
014	Winding insulation class H.	•	•	•	•	•	•	•	•	•	•	-	-	-
<b>Mounting arrangements</b>														
008	IM 2101 foot/flange mounted, IEC flange, from IM 1001 (B34 from B3).	•	•	•	•	•	•	-	-	-	-	-	-	-
009	IM 2001 foot/flange mounted, IEC flange, from IM 1001 (B35 from B3).	•	•	•	•	•	•	•	•	•	•	•	•	•
047	IM 3601 flange mounted, IEC flange, from IM 3001 (B14 from B5).	•	•	•	•	•	•	-	-	-	-	-	-	-
066	Modified for specified mounting position differing from IM B3 (1001), IM B5 (3001), B14 (3601), IM B35 (2001) & IM B34 (2101)	•	•	•	•	•	•	•	•	•	•	•	•	•
320	IM2001 foot/flat bottom flange mounted, from IM1001 (B35 flat bottom flange from B3)	•	•	•	•	•	•	-	-	-	-	-	-	-
<b>Painting</b>														
114	Special paint color, standard grade	•	•	•	•	•	•	•	•	•	•	•	•	•
<b>Protection</b>														
005	Protective roof, vertical motor, shaft down.	•	•	•	•	•	•	•	•	•	•	•	•	•
072	Radial seal at D-end. Not possible for 2-pole, 280 and 315 frames	•	•	•	•	•	•	•	•	•	•	•	•	•
158	Degree of protection IP65.	•	•	•	•	•	•	•	•	•	•	•	•	•
403	Degree of protection IP56.	•	•	•	•	•	•	•	•	•	•	•	•	•
784	Gamma-seal at D-end.	•	•	•	•	•	•	•	•	•	•	-	-	-
<b>Rating &amp; instruction plates</b>														
002	Restamping voltage, frequency and output, continuous duty.	•	•	•	•	•	•	•	•	•	•	•	•	•
095	Restamping output (maintained voltage, frequency), intermittent duty.	•	•	•	•	•	•	•	•	•	•	•	•	•
098	Stainless rating plate.	•	•	•	•	•	•	•	•	•	•	•	•	•
135	Mounting of additional identification plate, stainless.	•	•	•	•	•	•	•	•	•	•	•	•	•
159	Additional plate with text "Made in ..."	•	•	•	•	•	•	•	•	•	•	•	•	•
163	Frequency converter rating plate. Rating data according to quotation.	•	•	•	•	•	•	•	•	•	•	-	-	-
<b>Shaft &amp; rotor</b>														
069	Two shaft extensions according to catalog drawings.	•	•	•	•	•	•	•	•	•	•	-	-	-
070	Special shaft extension at D-End, standard shaft material	•	•	•	•	•	•	•	•	•	•	-	-	-
<b>Stator winding temperature sensors</b>														
121	Bimetal detectors, break type (NCC), (3 in series), 130 °C, in stator winding	•	•	•	•	•	•	•	•	•	•	-	-	-
122	Bimetal detectors, break type (NCC), (3 in series), 150 °C, in stator winding	•	•	•	•	•	•	•	•	•	•	•	•	•
435	PTC - thermistors (3 in series), 130 °C, in stator winding	•	•	•	•	•	•	•	•	•	•	•	•	•
436	PTC - thermistors (3 in series), 150 °C, in stator winding	○	○	○	○	○	○	○	○	○	○	○	○	○
439	PTC - thermistors (2x3 in series), 150 °C, in stator winding	-	-	-	-	-	•	•	•	•	•	-	-	-

○ = Included as standard | • = Available as option | - = Not applicable

Code/Variants, M2BAX	Frame size													
	71	80	90	100	112	132	160	180	200	225	250	280	315	355
441 PTC - thermistors (3 in series, 130 °C & 3 in series, 150 °C), in stator winding	•	•	•	•	•	•	•	•	•	•	•	•	•	•
445 Pt100 2-wire in stator winding, 1 per phase	•	•	•	•	•	•	•	•	•	•	•	•	•	•
<b>Terminal box</b>														
020 Detached terminal box.	•	•	•	•	•	•	•	•	•	•	•	-	-	-
021 Terminal box LHS (seen from D-end).	-	•	•	•	•	•	•	•	•	•	•	-	-	-
022 Cable entry LHS (seen from D-end).	•	•	•	•	•	•	•	•	•	•	•	-	-	-
180 Terminal box RHS (seen from D-end).	-	•	•	•	•	•	•	•	•	•	•	-	-	-
230 Standard metal cable glands.	•	•	•	•	•	•	•	•	•	•	•	•	•	•
375 Standard plastic cable gland	•	•	•	•	•	•	•	•	•	•	•	-	-	-
376 Two standard plastic cable glands	•	•	•	•	•	•	•	•	•	•	•	-	-	-
400 4 x 90 degr turnable terminal box.	•	•	•	•	•	•	○	○	○	○	○	○	○	○
413 Extended cable connection, no terminal box.	•	•	•	•	•	•	•	•	•	•	•	-	-	-
418 Separate terminal box for auxiliaries, standard material.	•	•	•	•	•	•	•	•	•	•	•	-	-	-
447 Top mounted separate terminal box for monitoring equipment.	-	-	-	-	-	-	-	-	-	-	-	•	•	•
468 Cable entry from D-end.	•	•	•	•	•	•	•	•	•	•	•	-	-	-
469 Cable entry from N-end.	•	•	•	•	•	•	•	•	•	•	•	-	-	-
731 Two standard metal cable glands.	•	•	•	•	•	•	•	•	•	•	•	-	-	-
<b>Testing</b>														
145 Type test report from a catalogue motor, 400V 50Hz.	•	•	•	•	•	•	•	•	•	•	•	•	•	•
146 Type test with report for one motor from specific delivery batch.	•	•	•	•	•	•	•	•	•	•	•	-	-	-
148 Routine test report.	•	•	•	•	•	•	•	•	•	•	•	•	•	•
<b>Variable speed drives</b>														
701 Insulated bearing at N-end.	-	-	-	-	-	-	-	-	-	-	-	•	•	•
704 EMC cable entry.	-	-	-	-	-	-	-	-	-	-	-	•	•	•

○ = Included as standard | • = Available as option | - = Not applicable



# Mechanical design

## Bearings

General performance motors are normally fitted with single-row deep-groove ball bearings, as shown in the table below.

If the bearing at the D-end is replaced with a roller bearing (NU- or NJ-), higher radial forces can be handled. Roller bearings are suitable for belt-drive applications and can be ordered with variant code 037.

### Standard and alternative designs

Motor size	Poles	Standard design	
		Deep groove ball bearings	
		D-end	N-end
71	2-6	6203-2Z/C3	6202-2Z/C3
80	2-6	6204-2Z/C3	6203-2Z/C3
90	2-6	6205-2Z/C3	6204-2Z/C3
100	2-6	6206-2Z/C3	6205-2Z/C3
112	2-6	6206-2Z/C3	6205-2Z/C3
132	2 - 6	6208-2Z/C3	6208-2Z/C3
160	2 - 6	6209-2Z/C3	6209-2Z/C3
180	2 - 6	6210-2Z/C3	6209-2Z/C3
200	2 - 6	6212-2Z/C3	6209-2Z/C3
225	2 - 6	6213-2Z/C3	6210-2Z/C3
250	2 - 6	6215-2Z/C3	6212-2Z/C3
280	2 - 6	6217/C3	6217/C3
315	2	6217/C3	6217/C3
315	4 - 6	6219/C3	6217/C3
355	2	6219/C3	6219/C3
355	4 - 6	6222/C3	6219/C3

### Axially-locked bearings

All motors are equipped as standard with an axially locked bearing at the D-end.

# Mechanical design

## Radial forces

### Pulley diameter

When the desired bearing life has been determined, the minimum permissible pulley diameter can be calculated with  $F_R$  as follows:

$$D = \frac{1.9 \cdot 10^7 \cdot K \cdot P}{n \cdot F_R}$$

#### Where:

D:	pulley diameter, mm
P:	power requirement, kW
n:	motor speed, r/min.
K:	belt tension factor, dependent on belt type and type of duty. A common value for V-belts is 2.5
$F_R$ :	permissible radial force

### Permissible loading on the shaft

The following table shows permissible radial forces on the shaft in Newtons, assuming zero axial force, a 25 °C ambient temperature, and normal conditions. The values are given for a calculated bearing life of 20 000 and 40 000 hours per motor size.

These calculated values further assume mounting position IM B3 (foot-mounted), with force directed sideways. In some cases, the strength of the shaft affects permissible forces.

Permissible loads of simultaneous radial and axial forces can be supplied on request.

If the radial force is applied between points  $X_0$  and  $X_{max}$ , the permissible force  $F_R$  can be calculated with the following formula:

$$F_R = F_{X_0} - \frac{X}{E} (F_{X_0} - F_{X_{max}})$$

#### Where:

E:	length of the shaft extension in the standard version
----	---

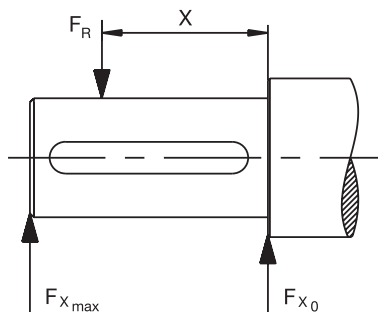

## Permissible radial forces, M2BAX motor sizes 71-355, IE2

Motor size	Poles	Length of shaft extension E (mm)	Basic design with deep groove ball bearings			
			20,000 h		40,000 h	
			$F_{x0}$ (N)	$F_{xmax}$ (N)	$F_{x0}$ (N)	$F_{xmax}$ (N)
71	2	30	545	465	430	370
	4	30	685	585	545	465
	6	30	785	660	620	530
80	2	40	740	620	585	490
	4	40	925	775	730	615
	6	40	1065	890	840	705
90S	2	50	795	645	625	510
	4	50	1000	815	790	645
	6	50	1145	935	905	740
90L	2	50	795	660	630	520
	4	50	1005	830	790	655
	6	50	1150	950	910	750
100	2	60	1110	895	875	705
	4	60	1395	1120	1100	885
	6	60	1605	1290	1265	1020
112	2	60	1120	925	885	730
	4	60	1405	1160	1105	915
	6	60	1615	1335	1275	1050
132S	2	80	1630	1270	1285	1000
	4	80	2055	1600	1620	1260
	6	80	2360	1840	1860	1450
132M	4	80	2075	1665	1630	1310
	6	80	2375	1905	1865	1495
	160	2	110	1945	1510	1545
4		110	2455	1905	1945	1510
6		110	2835	2250	2245	1780
180	2	110	2095	1705	1660	1350
	4	110	2640	2145	2090	1700
	6	110	3025	2460	2395	1950
200	2	110	2815	2310	2230	1830
	4	110	3550	2910	2810	2305
	6	110	4065	3335	3220	2640
225	2	110	3335	2795	2640	2215
	4	140	4200	3370	3325	2670
	6	140	4810	3860	2805	3055
250	2	140	3965	3220	3140	2550
	4	140	4995	4060	3955	3215
	6	140	5715	4645	4525	3675
280S	2	140	4855	3960	3840	3135
	4	140	6120	4995	4840	3955
	6	140	7000	5715	5540	4525
280SM	2	140	4900	4075	3875	3225
	4	140	6180	5140	4885	4065
315SM	2	140	4900	4180	3855	3285
	4	170	8120	6715	6415	5300
	6	170	9270	7660	7305	6040
315ML	2	140	4925	4275	3860	3350
	4	170	8185	6910	6450	5445
	6	170	9335	7885	7340	6200
355	2	140	6365	5585	4980	4370
	4	210	10530	8700	8260	6825
	6	210	12050	9955	9445	7805

# Mechanical design

## Axial forces

The following tables present permissible axial forces on the shaft in Newtons, assuming zero radial force, a 25 °C ambient temperature, and normal conditions. The values are given for a calculated bearing life of 20,000 and 40,000 hours per motor size.

At 60 Hz, the values must be reduced by 10 percent, and for two-speed motors, the higher speed determines permissible axial force. Permissible loads of simultaneous radial and axial forces can be supplied on request.

For axial force  $F_{AD}$ , it is assumed that the D-bearing is locked with a locking ring.

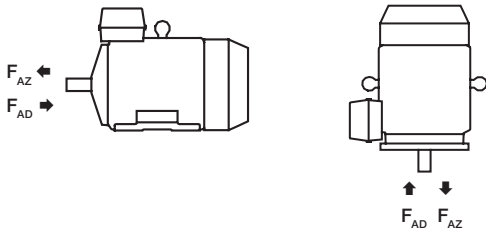

Mounting arrangement IM B3

Mounting arrangement IM V1

Motor size	Poles	Length of shaft extension E (mm)	Mounting arrangement IM B3			
			Deep groove ball bearings			
			20,000 h		40,000 h	
			$F_{AD}(N)$	$F_{AZ}(N)$	$F_{AD}(N)$	$F_{AZ}(N)$
225	2	110	2440	2210	1845	1615
	4	140	3195	2965	2395	2170
	6	140	3745	3520	2810	2580
250	2	140	2860	2620	2155	1920
	4	140	3765	3525	2825	2585
	6	140	4420	4180	3310	3070
280	2	140	4360	2360	3490	1490
	4	140	5475	3475	4310	2310
	6	140	6320	4320	4945	2945
315	2	140	4180	2180	3325	1325
	4	170	6750	4750	5220	3220
	6	170	7700	5700	5900	3900
355	2	140	5020	3305	3890	2180
	4	210	8090	6320	6090	4375
	6	210	9315	7605	7015	5300

### Permissible axial forces, M2BAX motor sizes 71-355, IE2

Motor size	Poles	Length of shaft extension E (mm)	Mounting arrangement IM B3			
			Deep groove ball bearings			
			20,000 h		40,000 h	
			$F_{AD}(N)$	$F_{AZ}(N)$	$F_{AD}(N)$	$F_{AZ}(N)$
71	2	30	580	300	465	185
	4	30	725	445	580	300
	6	30	810	530	670	390
80	2	40	750	430	595	275
	4	40	940	620	750	430
	6	40	1055	735	870	550
90	2	50	845	445	675	275
	4	50	1050	650	840	440
	6	50	1175	775	935	535
100	2	60	1175	615	940	380
	4	60	1465	905	1175	615
	6	60	1640	1080	1305	745
112	2	60	1175	615	935	375
	4	60	1460	900	1170	610
	6	60	1635	1075	1300	740
132	2	80	1675	795	1415	535
	4	80	2110	1230	1665	785
	6	80	2450	1570	1950	1070
160	2	110	1665	1205	1300	840
	4	110	2135	1675	1650	1190
	6	110	2465	2005	1895	1435
180	2	110	1730	1275	1345	890
	4	110	2215	1755	1705	1245
	6	110	2590	2130	1990	1530
200	2	110	2240	1780	1725	1265
	4	110	2900	2445	2215	1755
	6	110	3400	2945	2595	2135

# Terminal box

## Standard terminal box, M2BAX motor sizes 71-355, IE2

### Terminal boxes

The pictures below show standard terminal boxes.



Terminal box for motor sizes 71 to 132

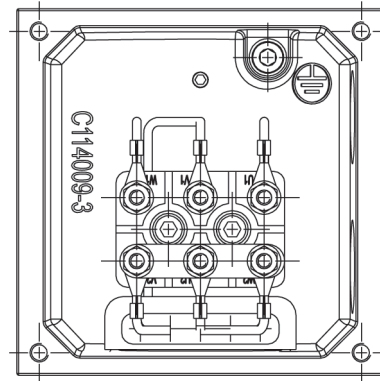

Terminal board for motor sizes 71 to 132



Terminal box for motor sizes 160 to 250

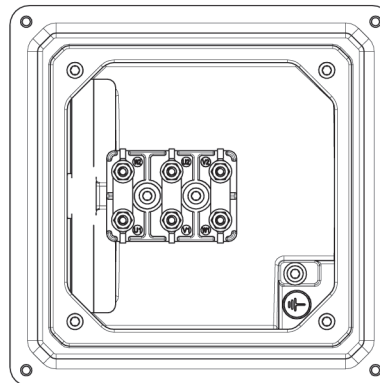

Terminal board for motor sizes 160 to 250



Terminal box for motor sizes 280 to 355

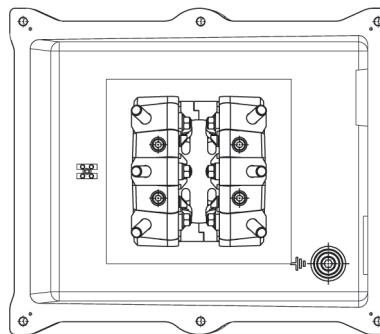

Terminal board for motor sizes 280 to 355

# Dimension drawings

## IE2 General performance cast iron M2BAX motors, 71-132

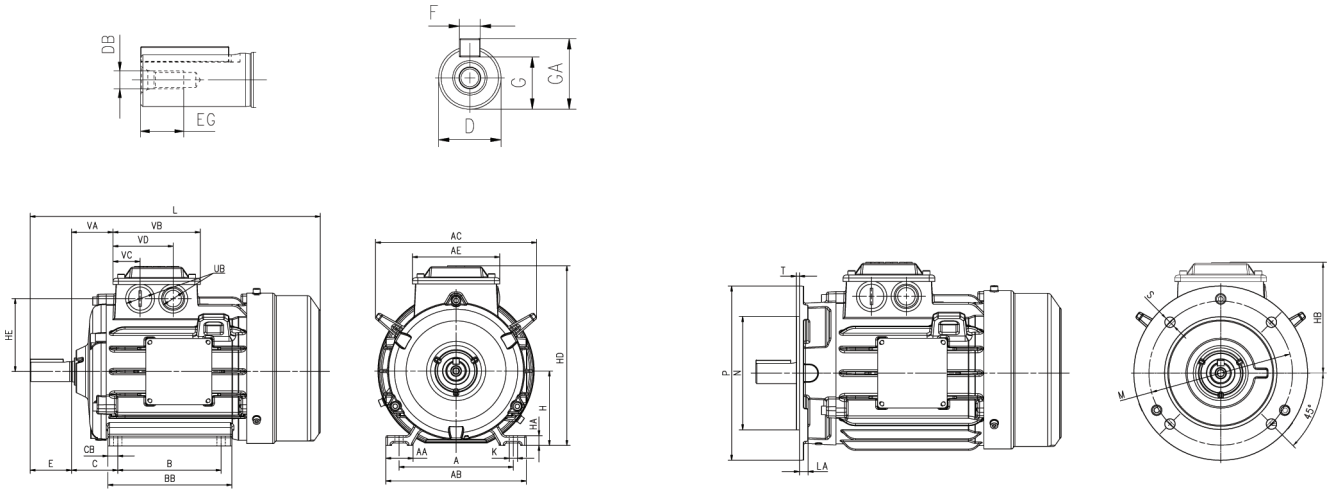

Foot-mounted motor IM1001, B3 and Flange-mounted motor IM 3001, B5

### General performance M2BAX 71-132, IE2

Motor size	AE	D	DB	E	EG	F	G	GA	H	HA	HE	L	UB	VA	VB	VC	VD
71	96	14	M5	30	12,5	5	11	16	71	9	65	257	M16X1,5	40	96	32	64
80	106	19	M6	40	16	6	15,5	21,5	80	12	72	309	M25X1,5	43	106	33	73
90S	106	24	M8	50	19	8	20	27	90	12	88	335	M25X1,5	50	106	33	73
90L	106	24	M8	50	19	8	20	27	90	12	88	351	M25X1,5	50	106	33	73
100	122	28	M10	60	22	8	24	31	100	15	100	376	M32X1,5	55	122	37	84
112	122	28	M10	60	22	8	24	31	112	15	100	411	M32X1,5	55	122	37	84
132S	122	38	M12	80	28	10	33	41	132	18	129	479	M32X1,5	65	122	37	84
132M	122	38	M12	90	28	10	33	41	132	18	129	521	M32X1,5	65	122	37	84

Motor size	IM B3 (IM 1001)										IM B5 (IM 3001)						
	A	AA	AB	AC	B	BB	C	CB	HD	K	HB	LA	M	N	P	S	T
71	112	30	136	147	90	110	45	10	175	7	104	9	130	110	160	10	3,5
80	125	33	154	161	100	125	50	12,5	192	10	112	10	165	130	200	12	3,5
90S	140	33	170	195	100	124	56	12	217	10	127	10	165	130	200	12	3,5
90L	140	33	170	195	125	150	56	12	217	10	127	10	165	130	200	12	3,5
100	160	38	200	218	140	170	63	15	240	12	141	11	215	180	250	14,5	4
112	190	48	230	218	140	170	70	15	252	12	141	11	215	180	250	14,5	4
132S	216	53	262	270	140	170	89	16	301	12	170	12	265	230	300	14,5	4
132M	216	53	262	270	178	210	89	16	301	12	170	12	265	230	300	14,5	4

Motor size	IM B14 (IM 3601)					Tolerances	
	M	N	P	S	T		
71	85	70	105	M6	2,5	A, B	±0,4
80	100	80	120	M6	3	D	ISO k6 < Ø 50 mm
90S	115	95	140	M8	3		ISO m6 > Ø 50 mm
90L	115	95	140	M8	3	F	ISO h9
100	130	110	160	M8	3,5	H	-0,5
112	130	110	160	M8	3,5	N	ISO j6
132S	165	130	200	M10	3,5	C	±0,8
132M	165	130	200	M10	3,5		

# Dimension drawings

## IE2 General performance cast iron M2BAX motors, 160-250

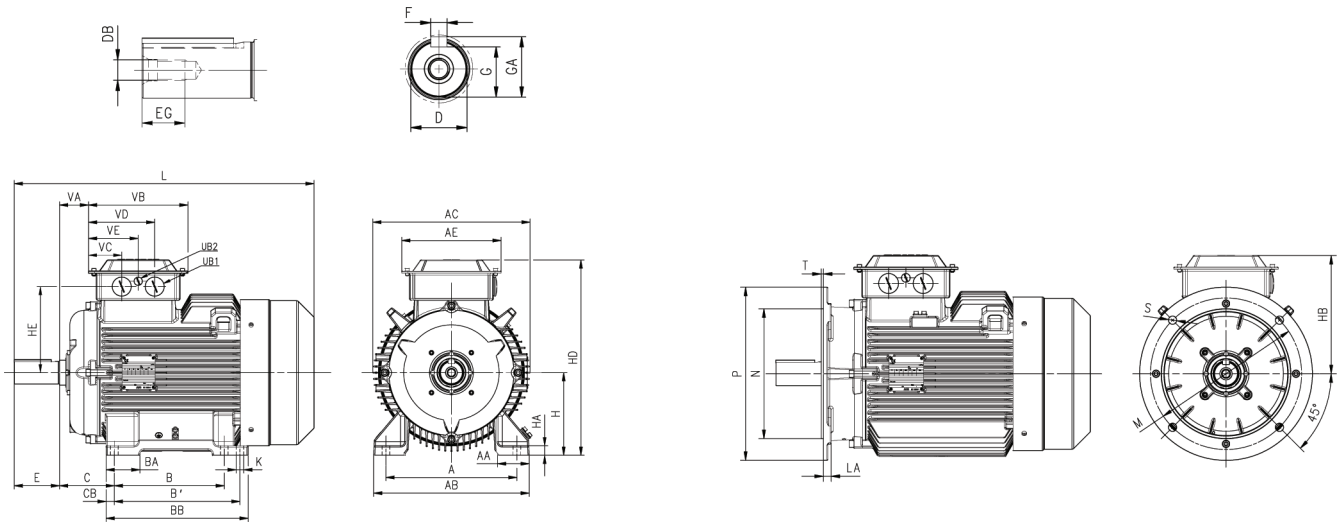

Foot-mounted motor IM 1001, B3 and Flange-mounted motor IM 3001, B5

### General performance M2BAX 160-250, IE2

Motor size	AE	D	DB	E	EG	F	G	GA	H	HA	HE	L	UB	VA	VB	VC	VD	VE
160 <sup>1)</sup>	241	42	M16	110	36	12	37	45	160	23	188	586,5	M40X1,5	59	241	81	161	121
180	241	48	M16	110	36	14	42,5	51,5	180	23	188	683	M40X1,5	59	241	81	161	121
200	241	55	M20	110	42	16	49	59	200	23	208	728	M40X1,5	70	241	81	161	121
225 2p	262	55	M20	110	42	16	49	59	225	23	228	824	M63X1,5	79	262	83	179	131
225 4-6 p	262	60	M20	140	42	18	53	64	225	23	228	854	M63X1,5	79	262	83	179	131
250 2 p	262	60	M20	140	42	18	53	64	250	23	248	882	M63X1,5	72	262	83	179	131
250 4-6 p	262	65	M20	140	42	18	58	69	250	23	248	882	M63X1,5	72	262	83	179	131

Motor size	IM B3 (IM 1001)										IM B5 (IM 3001)								
	A	AA	AB	AC	B	B'	BA	BB	C	CB	HD	K	HB	LA	M	N	P	S	T
160	254	67	310	338	210	254	69	294	108	20	413	14,5	253	16	300	250	350	18,5	5
180	279	72	340	338	241	279	68	318	121	19	134	14,5	253	16	300	250	350	18,5	5
200	318	77	378	382	267	305	82	345	133	20	173	18,5	273	18	350	300	400	18,5	5
225 2p	356	91	435	414	286	311	69	351	149	20	539	18,5	314	20	400	350	450	18,5	5
225 4-6 p	356	91	435	414	286	311	69	351	149	20	539	18,5	314	20	400	350	450	18,5	5
250 2 p	406	98	480	462	311	349	72	392	168	22	585	24	334	22	500	450	550	18,5	5
250 4-6 p	406	98	480	462	311	349	72	392	168	22	585	24	334	22	500	450	550	18,5	5

Tolerances	Footnotes
A, B	±0,4
D	<sup>1)</sup> 160MLB6, L=626.5
	ISO k6 < Ø 50 mm
	ISO m6 > Ø 50 mm
F	ISO h9
H	-0,5
N	ISO j6
C	±0,8

# Dimension drawings

## IE2 General performance cast iron M2BAX motors, 280-355

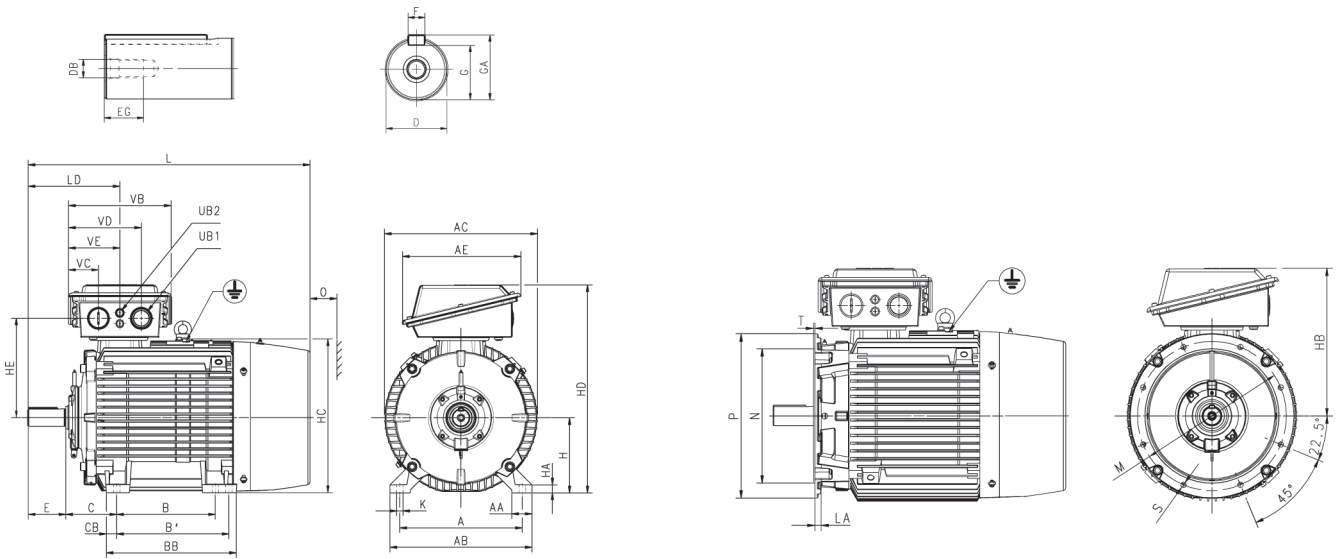

Foot-mounted motor IM 1001, B3 and Flange-mounted motor IM 3001, B5

### General performance M2BAX 280-355, IE2

Motor size	AE	D	DB	E	EG	F	G	GA	H	HA	HC	L	LD	O	UB1	UB2	VB	VC	VD	VE
280S 2p	442	65	M20	140	42	18	58	69	280	30	573	982	342	100	M63X1,5	M20X1,5	383	111	271	191
280S 4-6 p	442	75	M20	140	42	20	67,5	79,5	280	30	573	982	342	100	M63X1,5	M20X1,5	383	111	271	191
280SM 2p	442	65	M20	140	42	18	58	69	280	30	573	1052	342	100	M63X1,5	M20X1,5	383	111	271	191
280SM 4-6p	442	75	M20	140	42	20	67,5	79,5	280	30	573	1052	342	100	M63X1,5	M20X1,5	383	111	271	191
315SM 2p	442	65	M20	140	42	18	58	69	315	38	638	1216	348	115	M63X1,5	M20X1,5	383	111	271	191
315SM 4-6p	442	80	M20	170	42	22	71	85	315	38	638	1246	378	115	M63X1,5	M20X1,5	383	111	271	191
315ML 2p	442	65	M20	140	42	18	58	69	315	38	638	1326	347	115	M63X1,5	M20X1,5	383	111	271	191
315ML 4-6p	442	90	M24	170	50	25	81	95	315	38	638	1356	378	115	M63X1,5	M20X1,5	383	111	271	191
355SM 2p	493	70	M20	140	42	20	62,5	74,5	355	41	725	1399	399	130	M75X1,5	M20X1,5	383	111	271	191
355SM 4-6p	493	100	M24	210	50	28	90	106	355	41	725	1469	469	130	M75X1,5	M20X1,5	383	111	271	191

Motor size	IM B3 (IM 1001)										IM B5 (IM 3001)								
	A	AA	AB	AC	B	B'	BB	C	CB	HD	K	HB	LA	M	N	P	S	T	
280S 2p	457	75	530	571	368	-	431	190	38	775	24	495	21	500	450	550	18,5	5	
280S 4-6 p	457	75	530	571	368	-	431	190	38	775	24	495	21	500	450	550	18,5	5	
280SM 2p	457	75	530	571	368	419	485	190	38	775	24	495	21	500	450	550	18,5	5	
280SM 4-6p	457	75	530	571	368	419	485	190	38	775	24	495	21	500	450	550	18,5	5	
315SM 2p	508	100	590	644	406	457	563	216	52	849	28	534	27	600	550	660	24	6	
315SM 4-6p	508	100	590	644	406	457	563	216	52	849	28	534	27	600	550	660	24	6	
315ML 2p	508	100	590	644	457	508	612	216	52	849	28	534	27	600	550	660	24	6	
315ML 4-6p	508	100	700	644	457	508	612	216	52	849	28	534	27	600	550	660	24	6	
355SM 2p	610	120	700	739	500	560	698	254	72	933	35	578	22	740	680	800	24	6	
355SM 4-6p	610	120	700	739	500	560	698	254	72	933	35	578	22	740	680	800	24	6	

#### Tolerances

A, B	±0,4
D	ISO k6 < Ø 50 mm ISO m6 > Ø 50 mm
F	ISO h9
H	-0,5
N	ISO j6
C	±0,8



# Motors in brief

## IE2 General performance cast iron M2BAX motors, 71-132

Motor size		71	80	90	100	112	132
Stator and end shields	Material	Cast iron					
	Paint color shade	Munsell blue 8B 4.5/3.25					
	Corrosion class	C3 medium					
Feet	Material	Integrated cast iron					
Bearings	D-end	6203-2Z/C3	6204-2Z/C3	6205-2Z/C3	6206-2Z/C3	6206-2Z/C3	6208-2Z/C3
	N-end	6202-2Z/C3	6203-2Z/C3	6204-2Z/C3	6205-2Z/C3	6205-2Z/C3	6208-2Z/C3
Axially locked bearings	Retaining ring	Locked at D-end					
Bearing seals	D-end	V-ring					
Lubrication		Permanently lubricated shielded bearings					
Measuring nipples for condition monitoring of the bearings		Not Included					
Rating plate	Material	Stainless steel					
Terminal box	Material	Steel					
	Corrosion class	C3 medium					
	Cover screws	Zinc-electroplated steel					
Connections	Threaded openings	2xM16, 1xM16	2xM25, 1xM16		2xM32, 1xM16		
	Max Cu-area mm	4	6		10		
	Terminals	6 terminals for connection with cable lugs (not included)					
	Cable glands	Glands as option					
Fan	Material	Glass-fiber reinforced polypropylene					
Fan cover	Material	Steel					
	Paint color shade	Munsell blue 8B 4.5/3.25					
	Corrosion class	C3 medium					
Stator winding	Material	Copper					
	Insulation	Insulation class F. Temperature rise class B unless otherwise stated.					
	Winding protection	3 PTC thermistors, 150°C					
Rotor winding	Material	Pressure die-cast aluminum					
Balancing method		Half key balancing as standard					
Key ways		Open key way					
Drain holes		Drain holes with closable plastic plugs, open on delivery					
Enclosure		IP 55 Higher protection on request					
Cooling method		IC 411					
Lifting lugs		Integrated cast iron lifting lugs					

# Motors in brief

## IE2 General performance cast iron M2BAX motors, 160-250

Motor size	M2BAX	160	180	200	225	250
Stator and end shields	Material	Cast iron				
	Paint color shade	Munsell blue 8B 4.5/3.25				
	Corrosion class	C3 medium				
Feet	Material	Integrated cast iron				
Bearings	D-end	6209-2Z/C3	6210-2Z/C3	6212-2Z/C3	6213-2Z/C3	6215-2Z/C3
	N-end	6209-2Z/C3	6209-2Z/C3	6209-2Z/C3	6210-2Z/C3	6212-2Z/C3
Axially locked bearings	Retaining ring	Locked at D-end				
Bearing seals	D-end	V-ring				
Lubrication						
Measuring nipples for condition monitoring of the bearings		Not Included				
Rating plate	Material	Stainless steel				
Terminal box	Material	Steel				
	Corrosion class	C3 medium				
	Cover screws	Zinc-electroplated steel				
Connections	Threaded openings	2xM40, 1xM16			2xM63, 1xM16	
	Max Cu-area mm	35			70	
	Terminals	6 terminals for connection with cable lugs (not included)				
	Cable glands	Glands as option				
Fan	Material	Glass-fiber reinforced polypropylene				
Fan cover	Material	Steel				
	Paint color shade	Munsell blue 8B 4.5/3.25				
	Corrosion class	C3 medium				
Stator winding	Material	Copper				
	Insulation	Insulation class F. Temperature rise class B unless otherwise stated.				
	Winding protection	3 PTC thermistors, 150°C				
Rotor winding	Material	Pressure die-cast aluminum				
Balancing method		Half key balancing as standard				
Key ways		Open key way				
Drain holes		Drain holes with closable plastic plugs, open on delivery				
Enclosure		IP 55 Higher protection on request				
Cooling method		IC 411				
Lifting lugs		Integrated cast iron lifting lugs				

# Motors in brief

## IE2 General performance cast iron M2BAX motors, 280-355

Motor size	M2BAX	280	315	355
Stator and end shields	Material	Cast iron		
	Paint color shade	Munsell blue 8B 4.5/3.25		
	Corrosion class	C3 medium		
Feet	Material	Integrated cast iron		
Bearings	D-end	6217/C3	6217/C3 (2p) 6219/C3 (4-6p)	6219/C3 (2p) 6222/C3 (4-6p)
	N-end	6217/C3	6217/C3	6219/C3
Axially locked bearings	Retaining ring	Locked at D-end		
Bearing seals	D-end	V-ring		
Lubrication				
Measuring nipples for condition monitoring of the bearings		Not Included		
Rating plate	Material	Stainless steel		
Terminal box	Material	Cast iron		
	Corrosion class	C3 medium		
	Cover screws	Zinc-electroplated steel		
Connections	Threaded openings	2xM63, 2xM20		2xM75, 2xM20
	Max Cu-area mm	2x150	2x240	4x240
	Terminals	6 terminals for connection with cable lugs (not included)		
	Cable glands	Glands as option		
Fan	Material	Glass-fiber reinforced polypropylene		
Fan cover	Material	Steel		
	Paint color shade	Munsell blue 8B 4.5/3.25		
	Corrosion class	C3 medium		
Stator winding	Material	Copper		
	Insulation	Insulation class F. Temperature rise class B unless otherwise stated.		
	Winding protection	3 PTC thermistors, 150°C		
Rotor winding	Material	Pressure die-cast aluminum		
Balancing method		Half key balancing as standard		
Key ways		Open key way		
Drain holes		Drain holes with closable plastic plugs, open on delivery		
Enclosure		IP 55 Higher protection on request		
Cooling method		IC 411		
Lifting lugs		Separate steel lifting lugs		

# Total product offering

Motors, generators and mechanical power transmission products with a complete portfolio of services



ABB is the leading manufacturer of low, medium and high voltage motors and generators, and mechanical power transmission products. ABB products are backed by a complete portfolio of services. Our in-depth knowledge of virtually every type of industrial process ensures we always specify the best solution for your needs.

## Low and high voltage IEC induction motors

- Process performance motors
- General performance motors
- High voltage cast iron motors
- Induction modular motors
- Slip-ring modular motors
- Synchronous reluctance motors

## Low and medium voltage NEMA motors

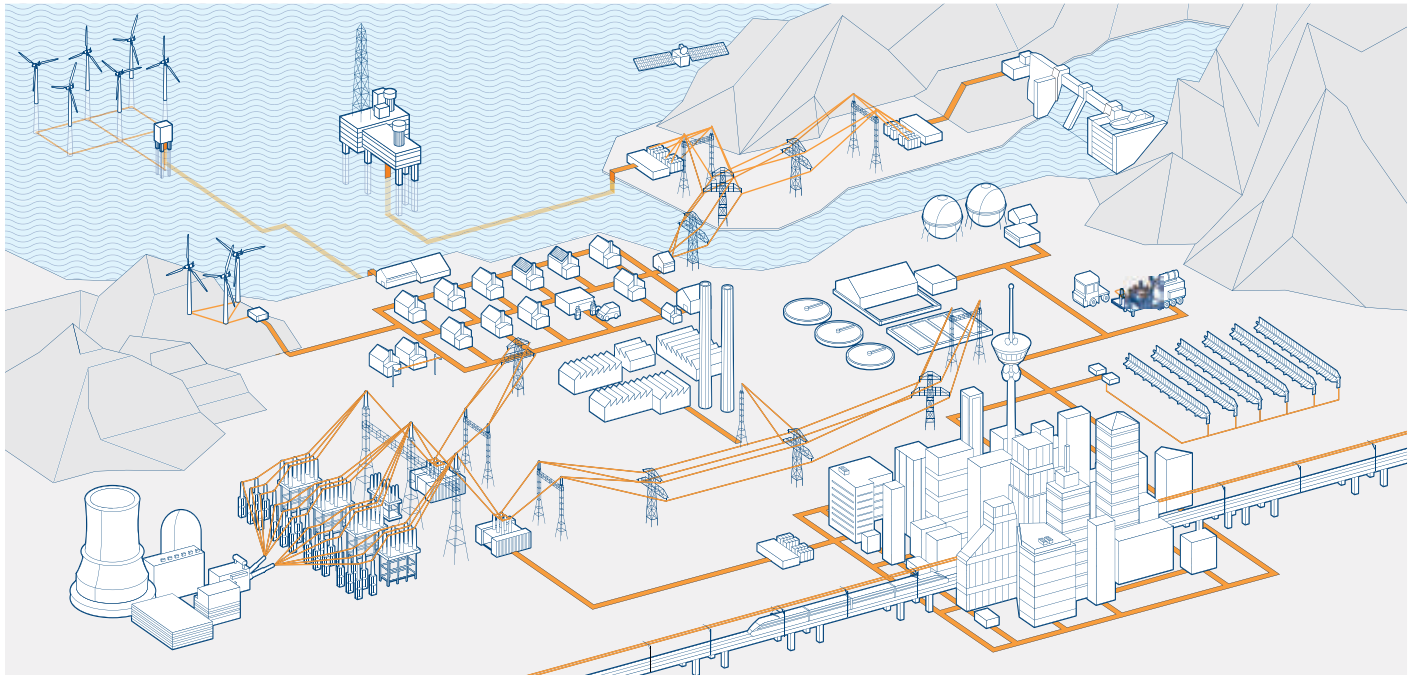
- Steel frame open drip proof (ODP) motors
- Weather protected, water cooled, fan ventilated
- Cast iron frame (TEFC)
- Air to air cooled (TEAAC) motors

## Motors and generators for explosive atmospheres

- IEC and NEMA motors and generators, for all protection types

## Synchronous motors

### Synchronous generators

- Synchronous generators for diesel and gas engines
- Synchronous generators for steam and gas turbines

## Wind power generators

## Generators for small hydro

## Other motors and generators

- Brake motors
- DC motors and generators
- Gear motors
- Marine motors and generators
- Single phase motors
- Motors for high ambient temperatures
- Permanent magnet motors and generators
- High speed motors
- Smoke extraction motors
- Wash down motors
- Water cooled motors
- Generator sets
- Roller table motors
- Low inertia motors
- Traction motors and generators

## Life cycle services

## Mechanical power transmission components, bearings, gearings

# Life cycle services and support

## From pre-purchase to migration and upgrades



**ABB offers a complete portfolio of services to ensure trouble-free operation and long product lifetimes. These services cover the entire life cycle. Local support is provided through a global network of ABB service centers and certified partners.**

### **Pre-purchase**

ABB's front-end sales organization can help customers to quickly and efficiently select, configure and optimize the right motor or generator for their application.

### **Installation and commissioning**

Professional installation and commissioning by ABB's certified engineers represent an investment in availability and reliability over the entire life cycle.

### **Engineering and consulting**

ABB's experts provide energy efficiency and reliability appraisals, advanced condition and performance assessments and technical studies.

### **Condition monitoring and diagnosis**

Unique services collect and analyze data to provide early warnings of problems before failures can occur. All critical areas of the equipment are covered.

### **Maintenance and field services**

ABB offers life cycle management plans and preventive maintenance products. The recommended four-level maintenance program covers the entire product lifetime.

### **Spare parts**

Spare parts and support are offered throughout the life cycle of ABB products. In addition to individual spares, tailored spare part packages are also available.

### **Repair and refurbishment**

Support for all ABB motors and generators and other brands is provided by ABB's global service organization. Specialist teams can also deliver emergency support.

### **Migration and upgrades**

Life cycle audits determine the optimum upgrades and migration paths. Upgrades range from individual components to direct replacement motors and generators.

### **Training**

Product and service training courses take a practical approach. The training ranges from standard courses to specially tailored programs to suit customer requirements.

### **Specialized support**

Specialized support is offered through ABB's global service organization. Local units provide major and minor repairs as well as overhauls and reconditioning.

### **Service contracts**

Service contracts are tailored to the customer's needs. The contracts combine ABB's entire service portfolio and 120 years of experience to deploy the optimal service practices.

# Contact us

[www.abb.com/motors&generators](http://www.abb.com/motors&generators)

We reserve the right to make technical changes or modify the contents of this document without prior notice. With regard to purchase orders, the agreed particulars shall prevail. ABB does not accept any responsibility what so ever for potential errors or possible lack of information in this document.

We reserve all rights in this document and in the subject matter and illustrations contained herein. Any reproduction, disclosure to third parties or utilization of its contents – in whole or in parts – is forbidden without prior written consent of ABB.

© Copyright 2014 ABB.

All rights reserved.

